

PERSPECTIVE SHOULD ONLY EVER
BE USED FOR MAKING
COOL SHIT EVEN COOLER

NO PERSPECTIVE W/O DEPTH
NO DEPTH WITHOUT COMPOSITION

YOUR FANTASY KINGDOM



- PROPS

- SETPIECES

| - MANMADE

NATURAL

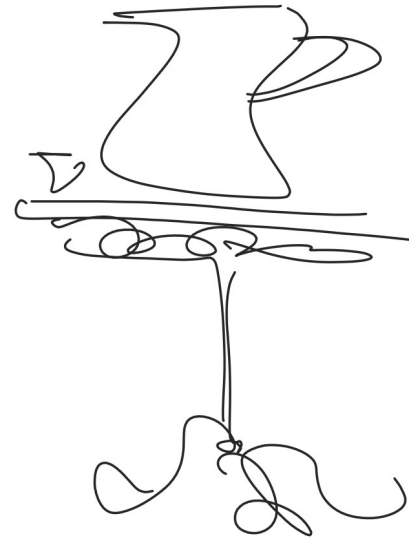
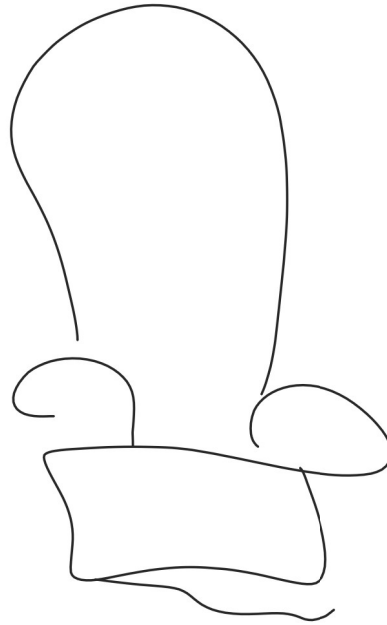

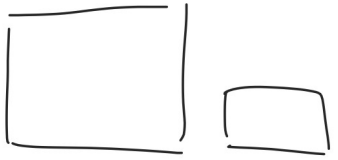

SIZE

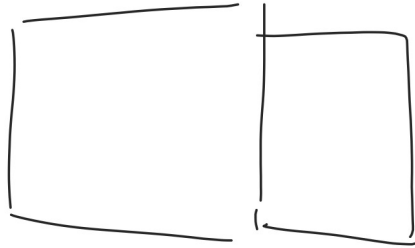

OVERLAP



STACKING



PLACEMENT

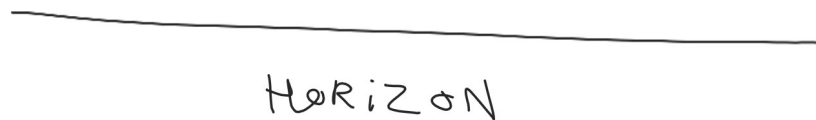
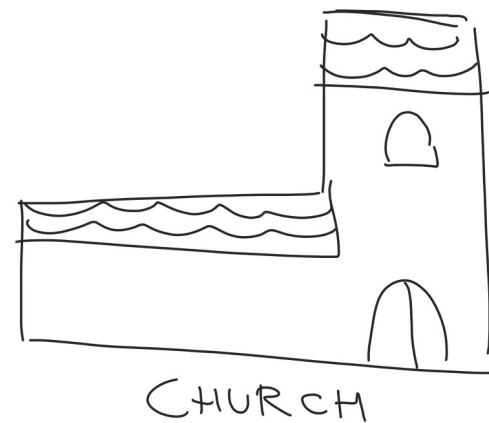
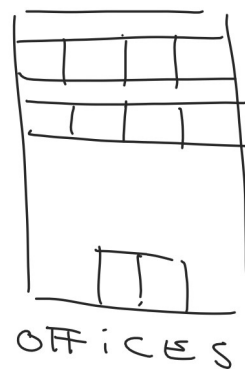
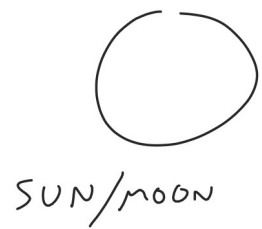

THUMBNAILS

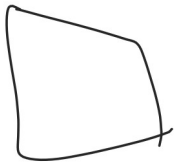
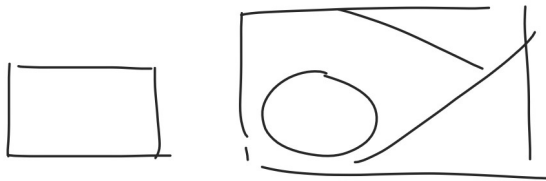
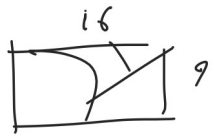

CLOSED & THREATENING



OPEN & INVITING

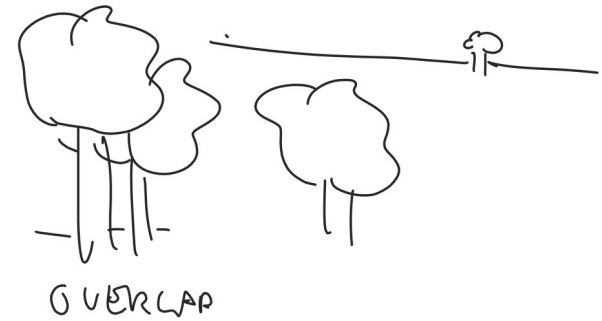

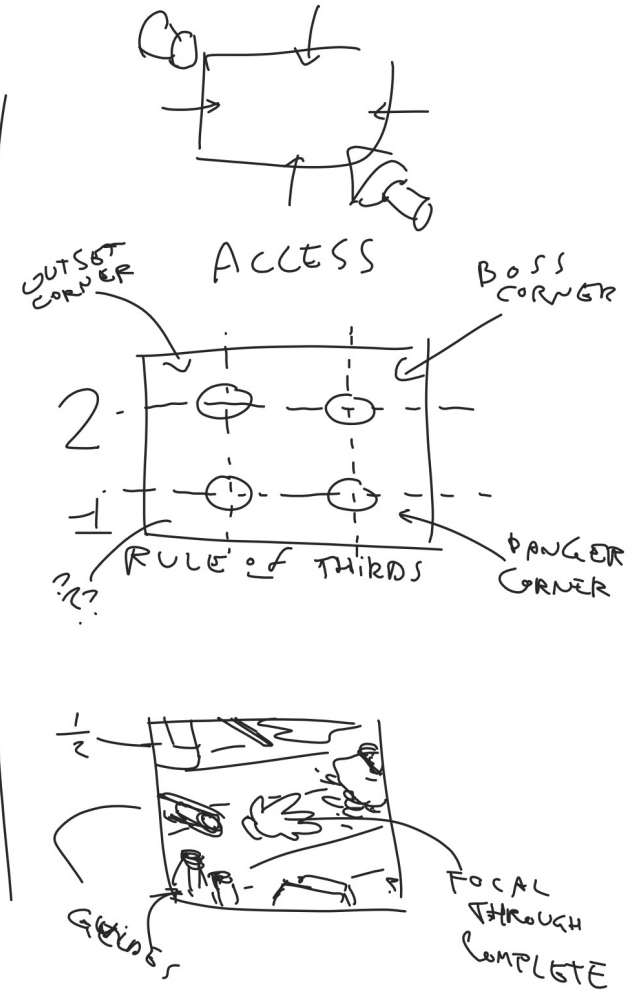
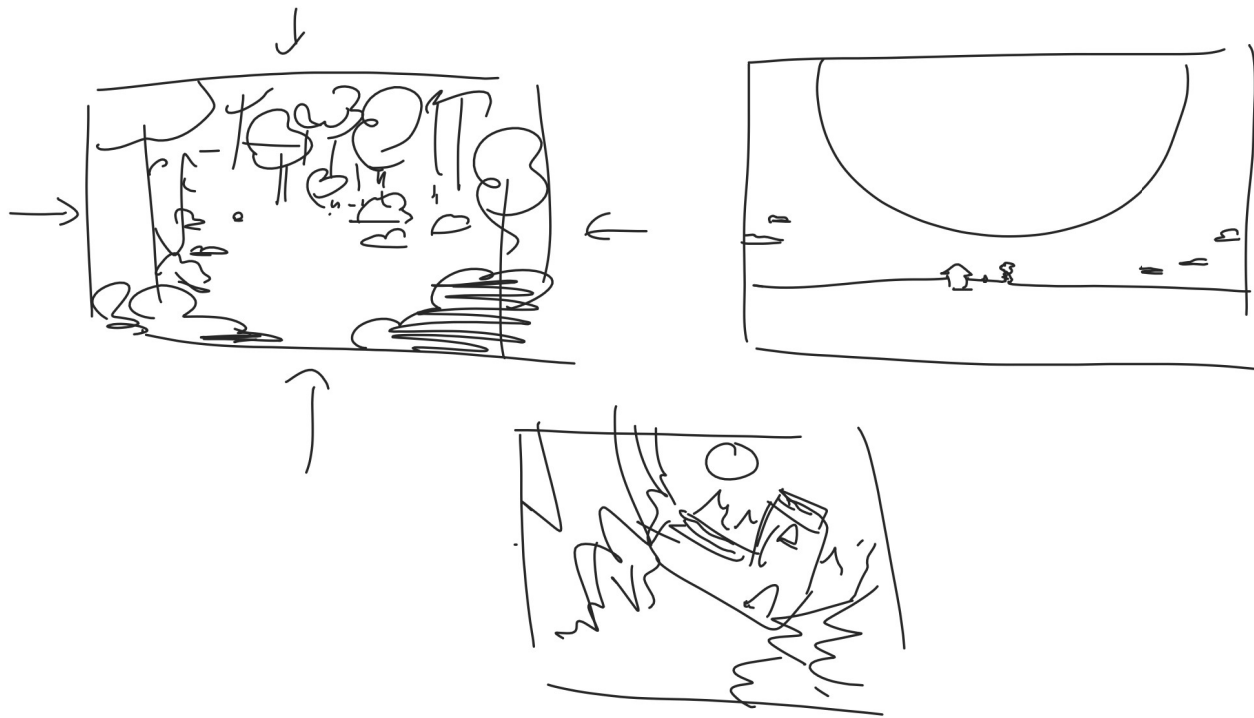

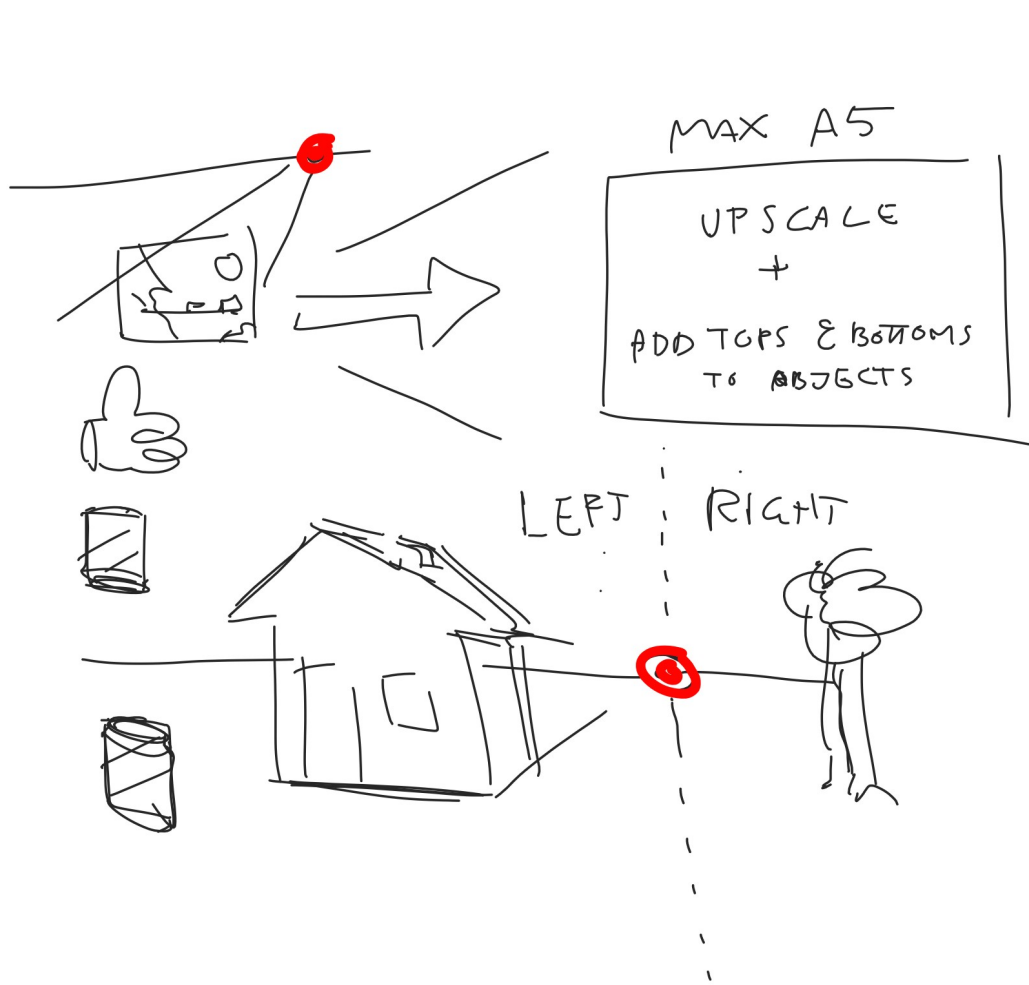

VANISHING POINT!
~~UP~~
~~DOWN~~
ON THE HORIZON

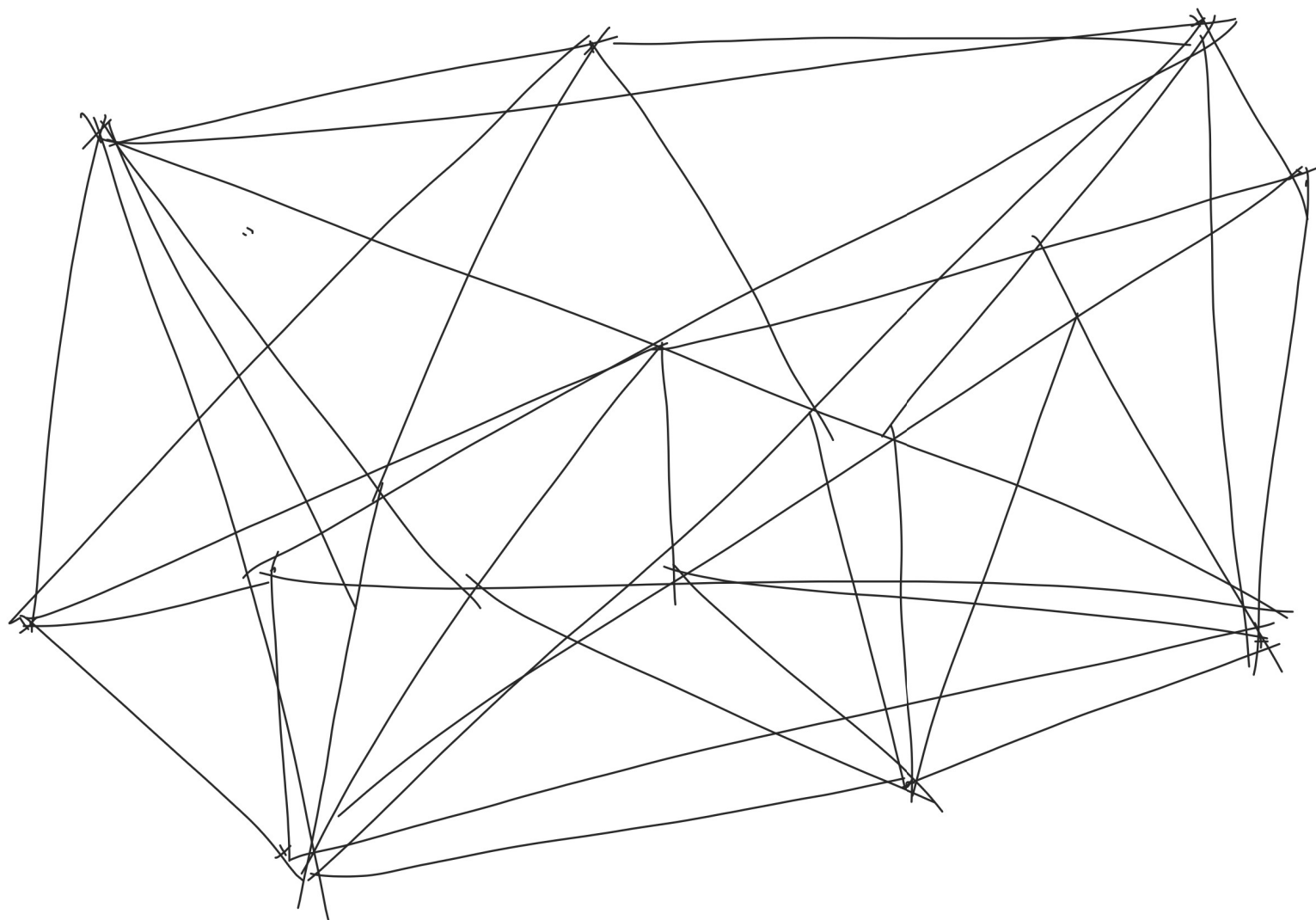

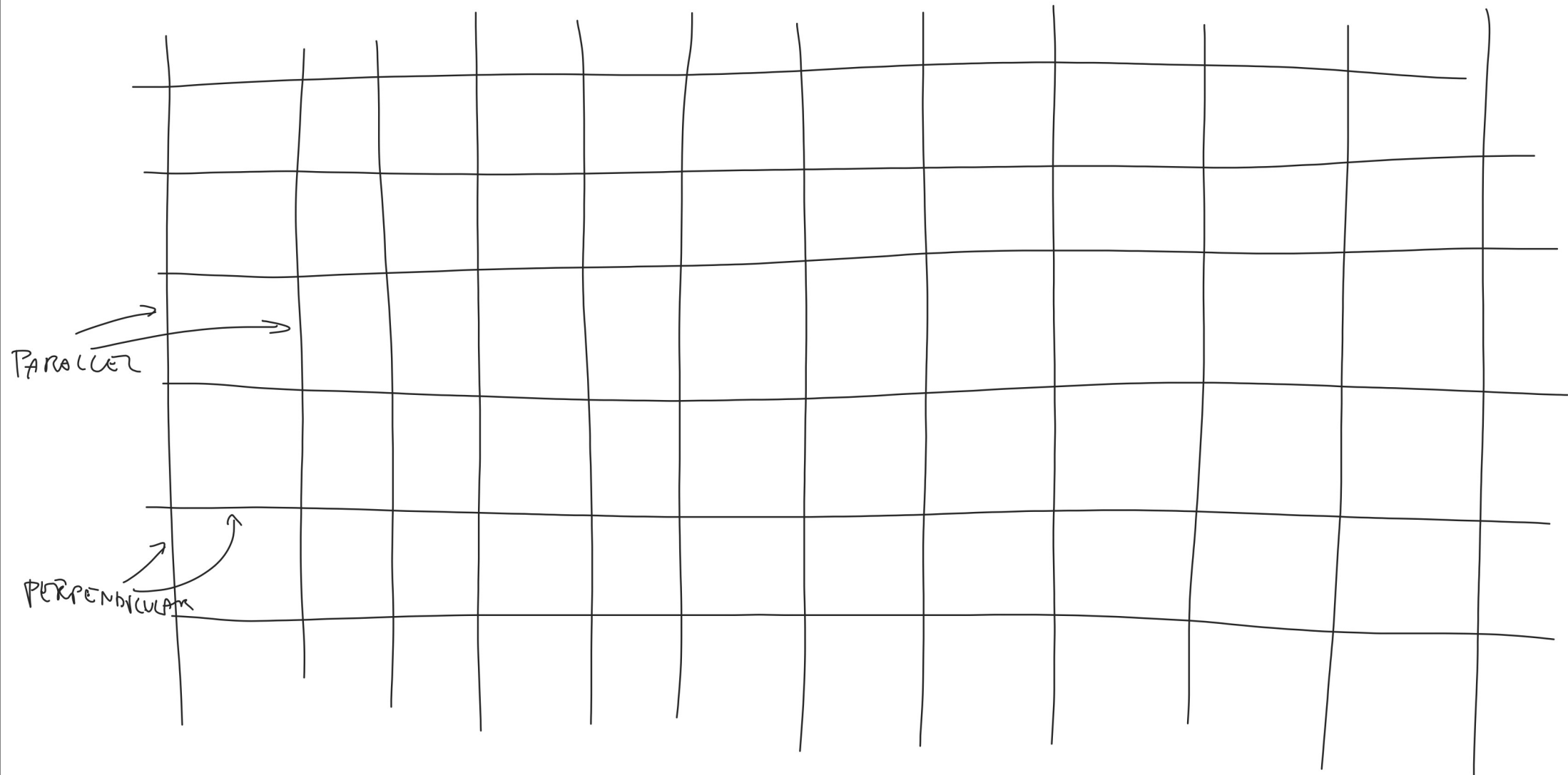

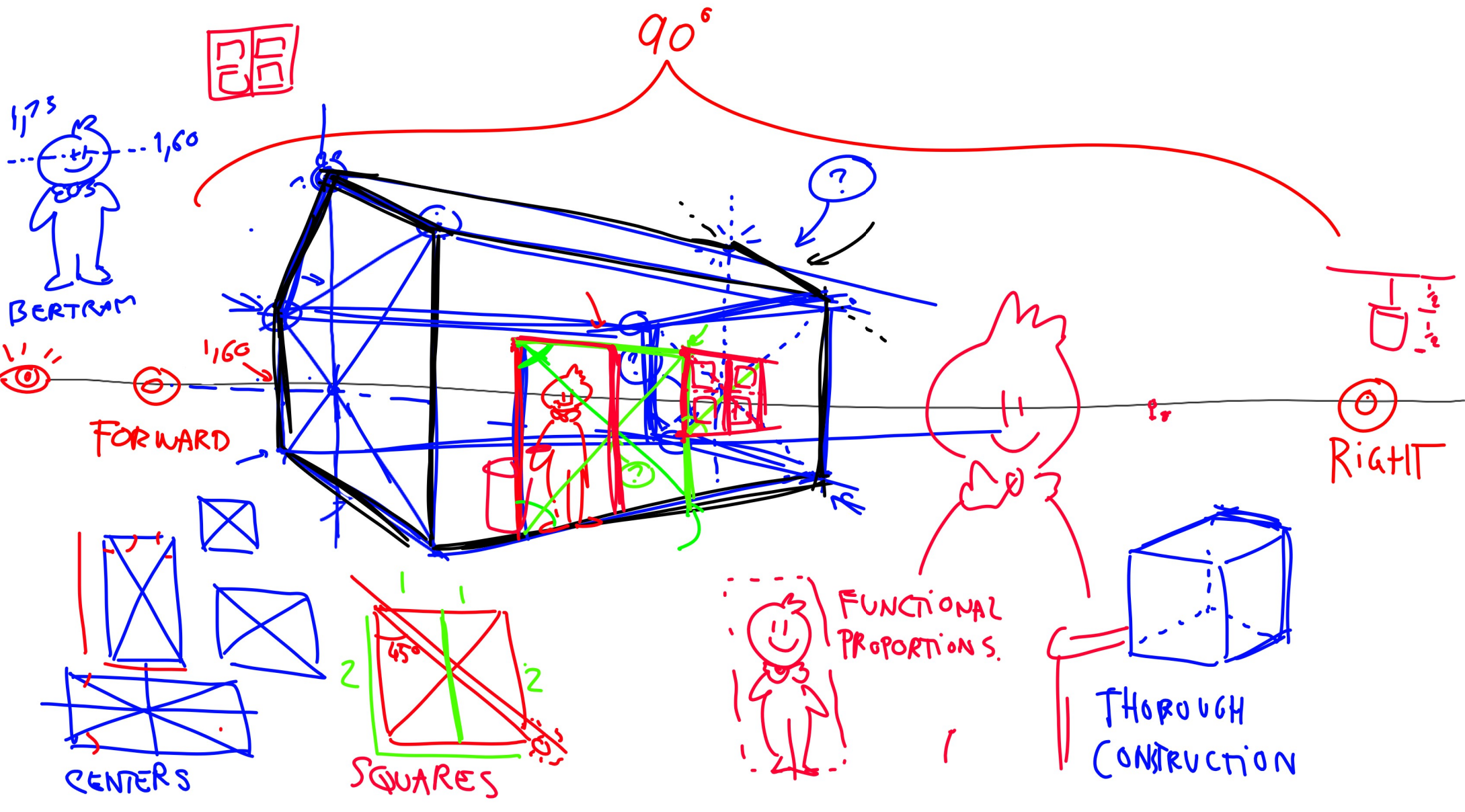

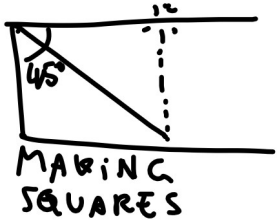
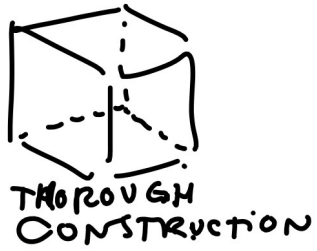
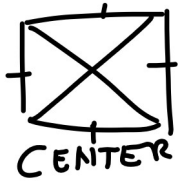

"SCAFFOLDING"

VANISHING
POINTS
=
1/5 pic/width
APART
(minimum!)

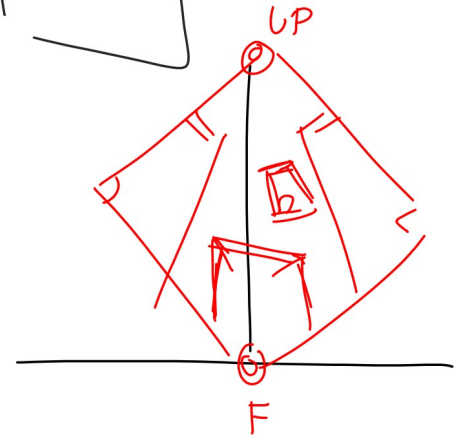
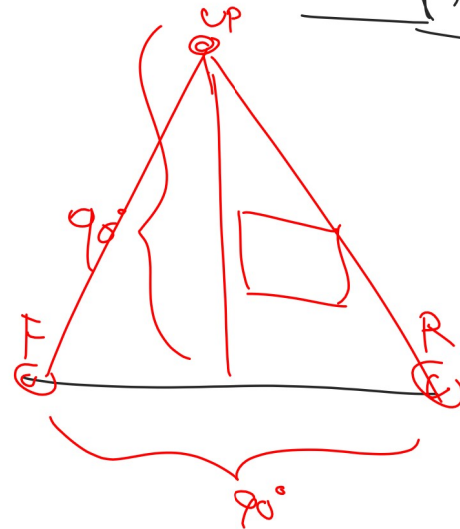
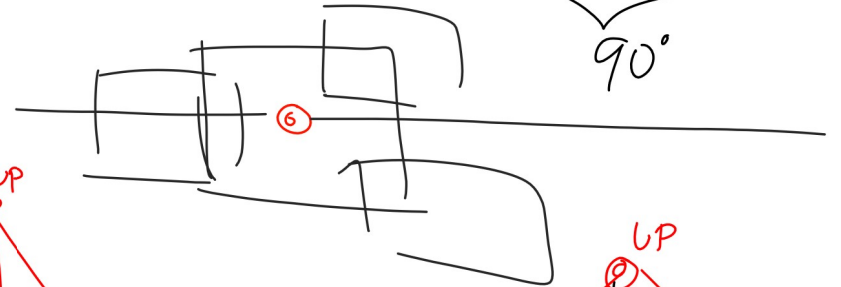
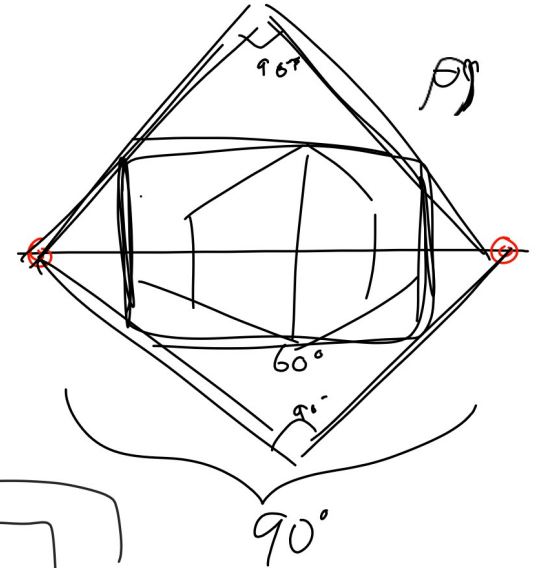

OBJECTS from Your CHILDHOOD BEDROOM

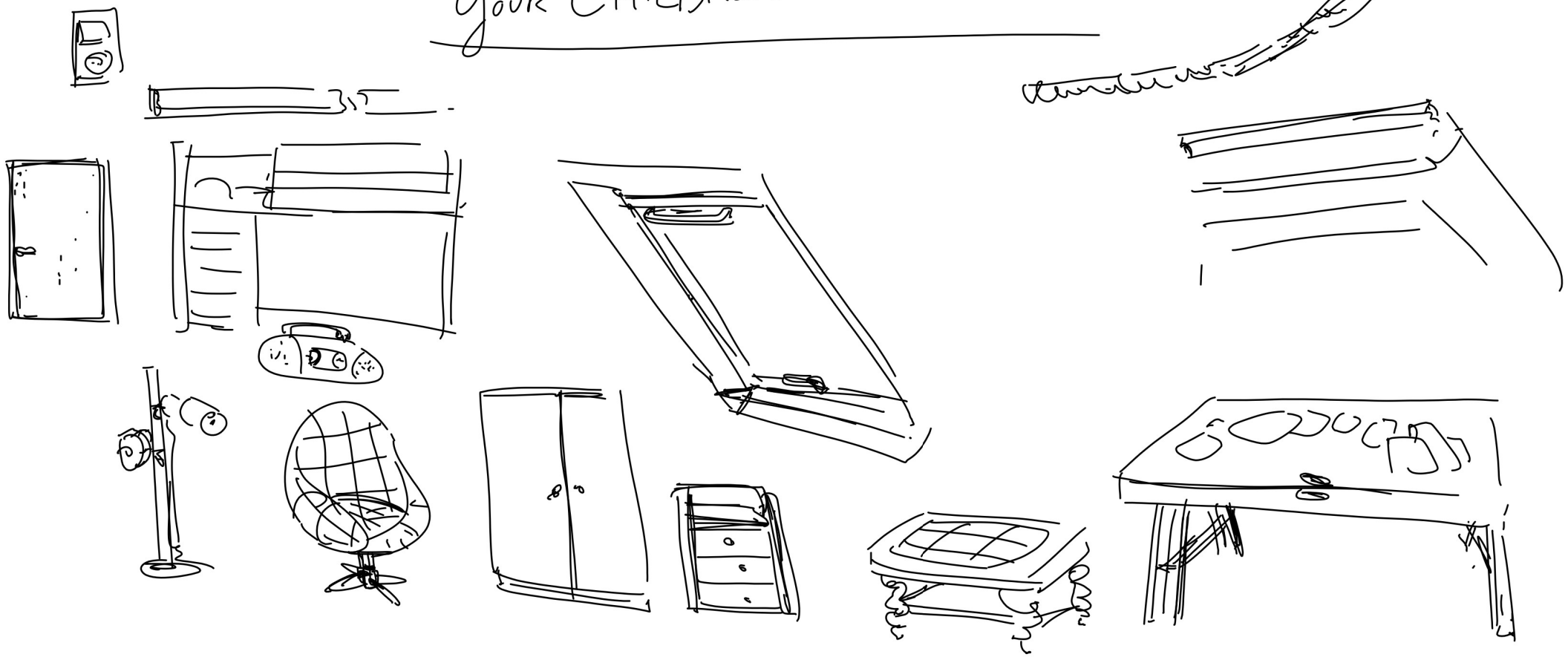

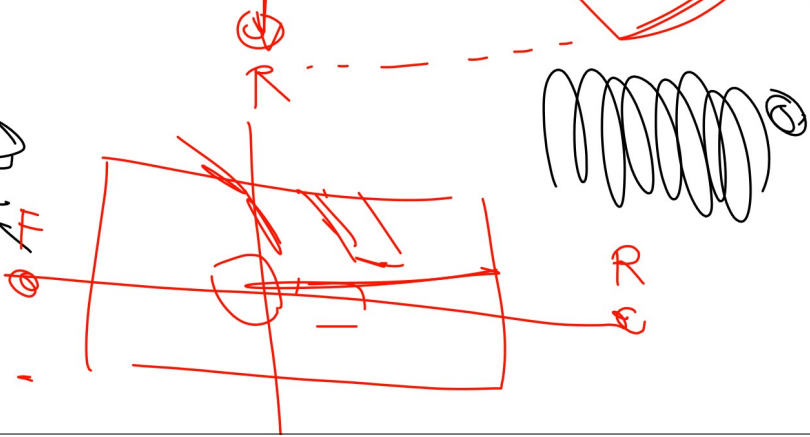
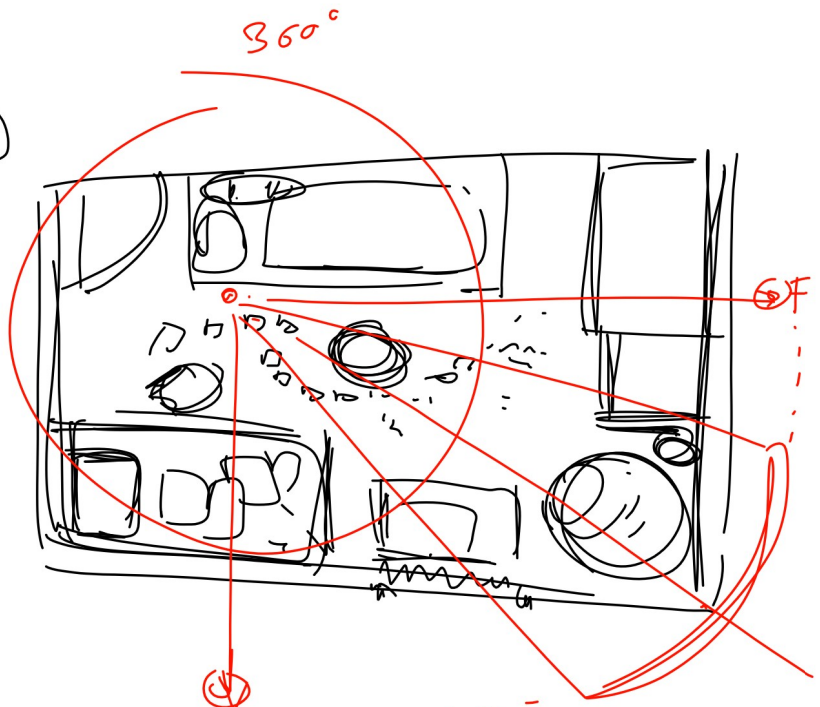

THUMBNAILS

HORROR
STORY!

- OR -

PLAYFUL
AFTERNOON

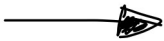
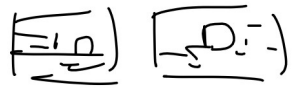

DEER
CROOKED



LOW



SIZE
UP

max A5



+ SCAFFOLDING

RENDER to Liking

for 10:00
WEDNESDAY

(I WON'T BE
HERE UNTIL
10:00!)

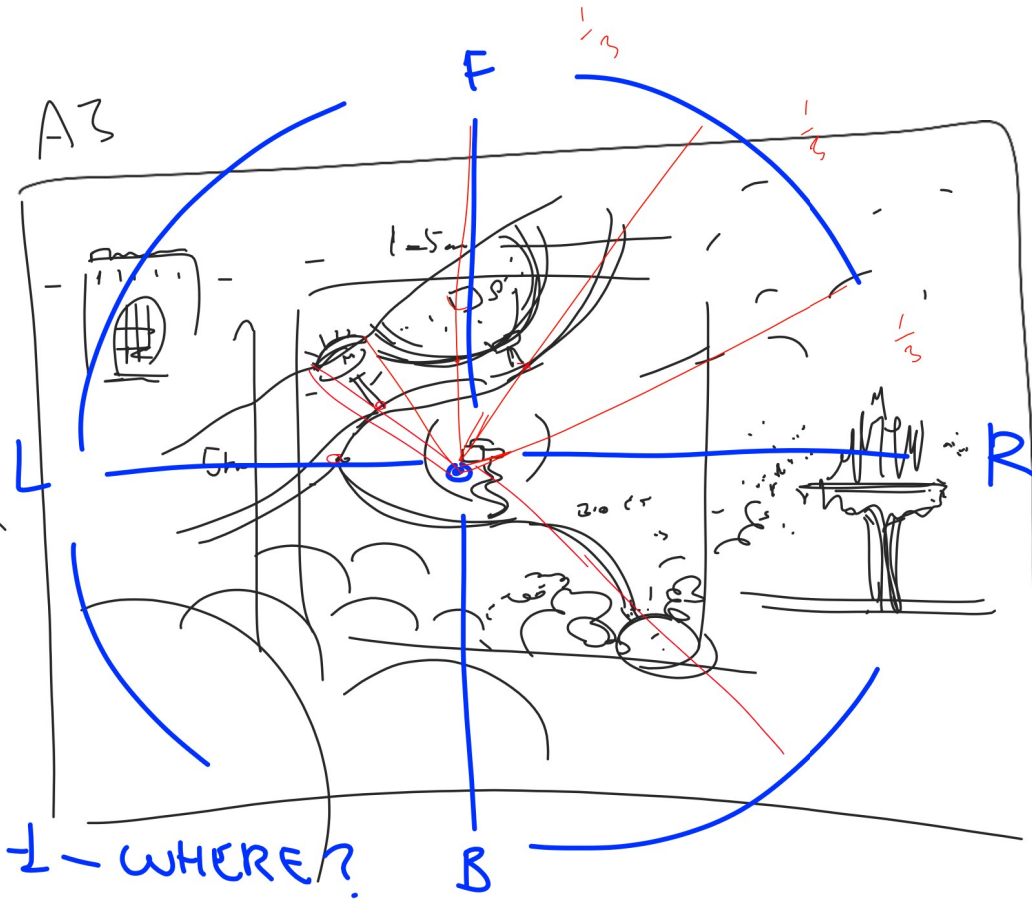

- 1 - WHERE? B
- 2 - HOW HIGH UP ARE YOU?
- 3 - GET CLOSE TO SOMETHING ☺

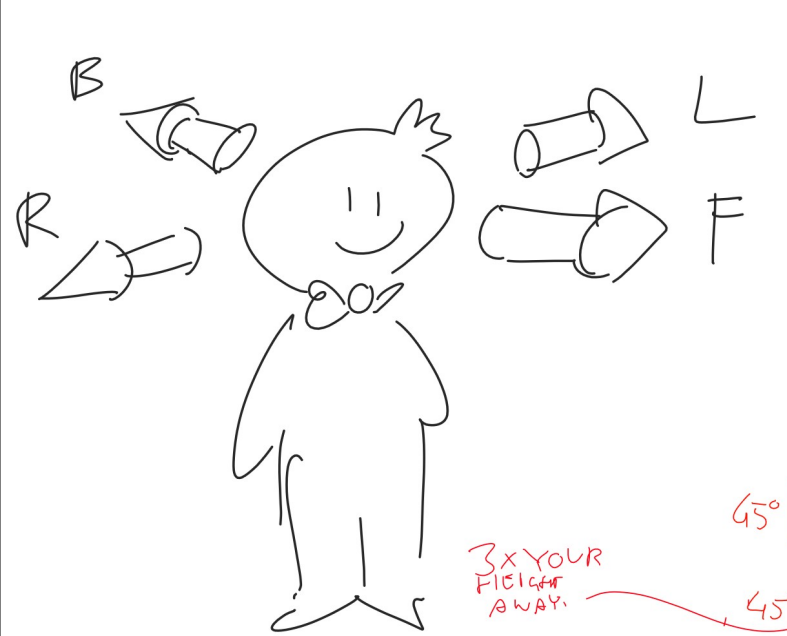

$90^\circ \times 4$
 $= 360^\circ$

3x YOUR
FLIGHT
AWAY.

YOUR
HEIGHT AWAY

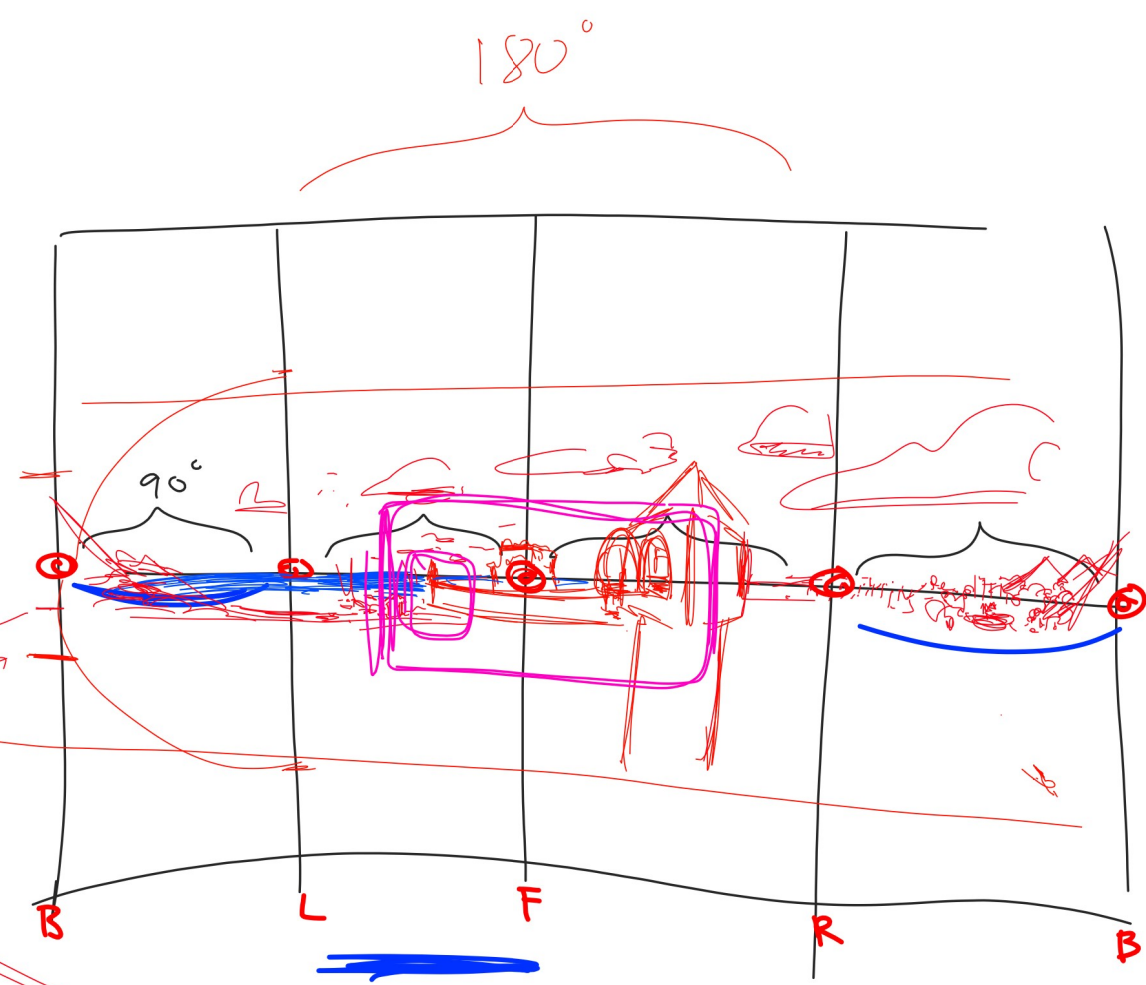
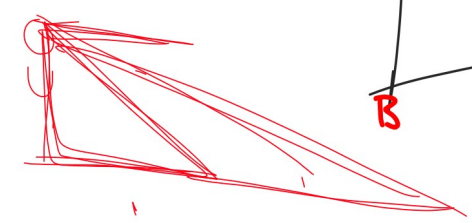

CURVILINEAR 180°

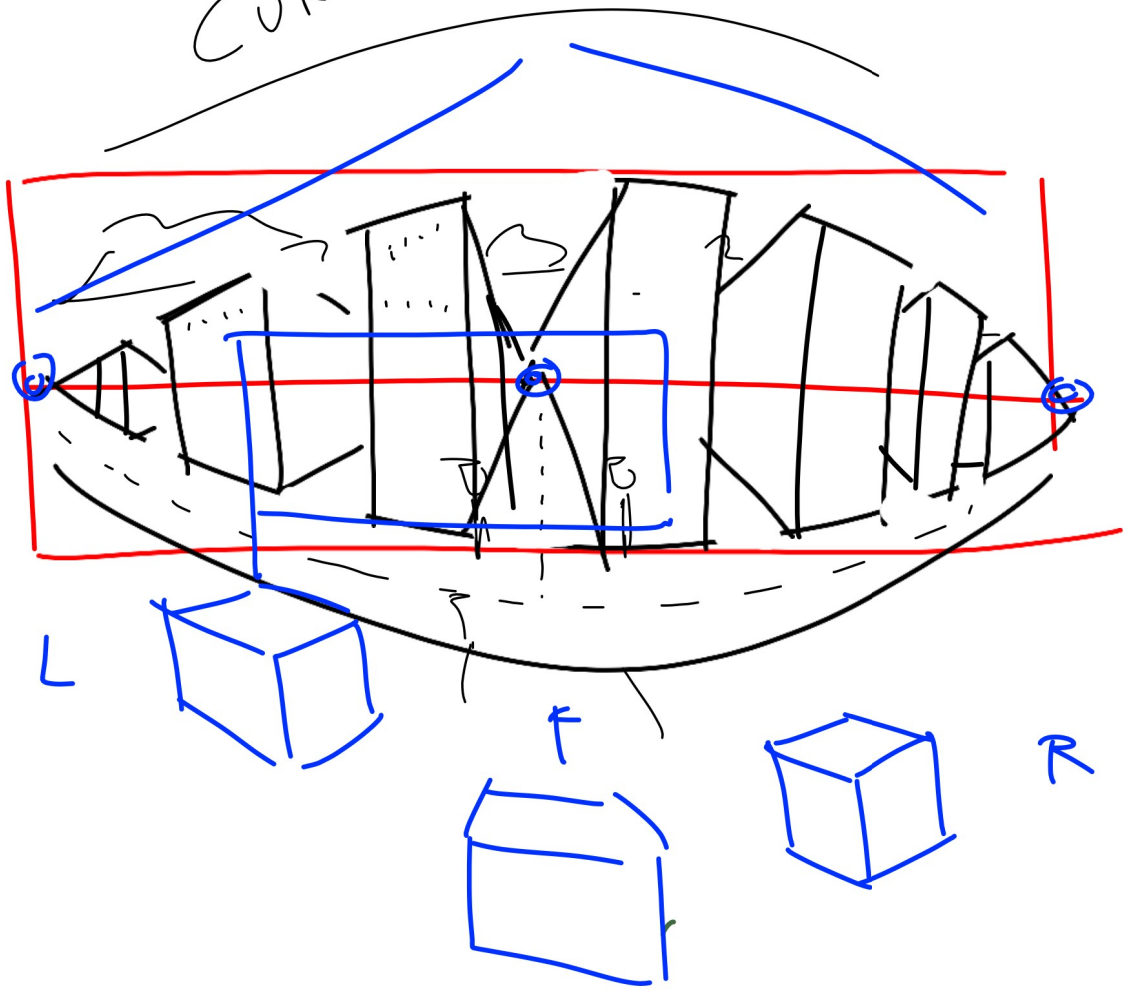

THREE THINGS on a DESERT ISLAND

- NOT THE REGULARS
- SHOULD FIT ON a LUGGAGE TROLLEY



- DRAW-ALONG 2 -

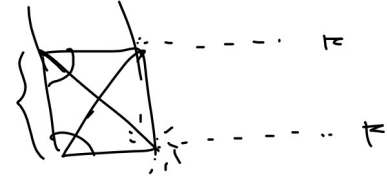
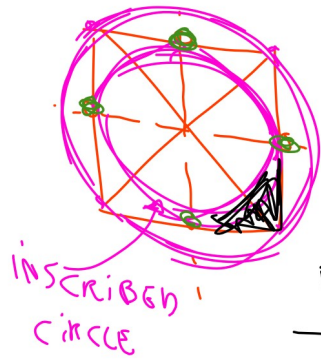
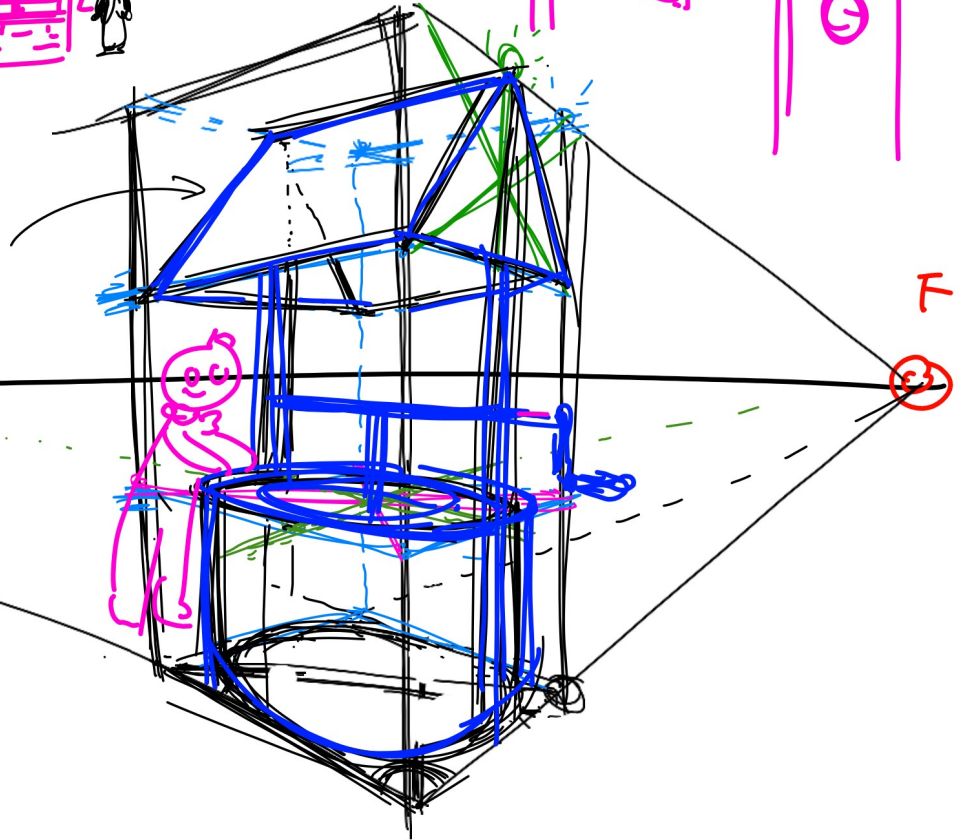
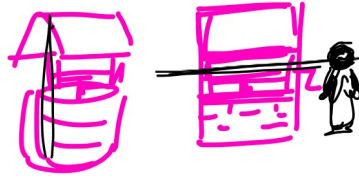
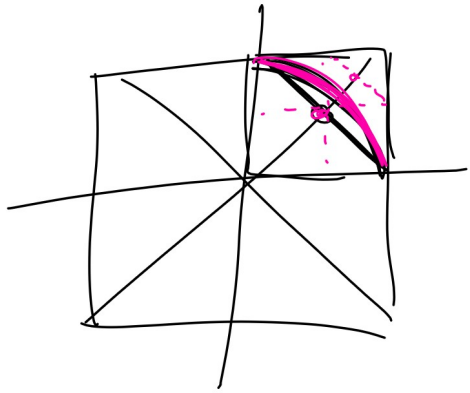

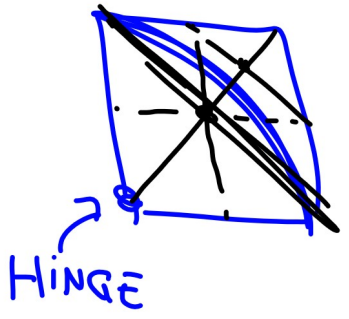
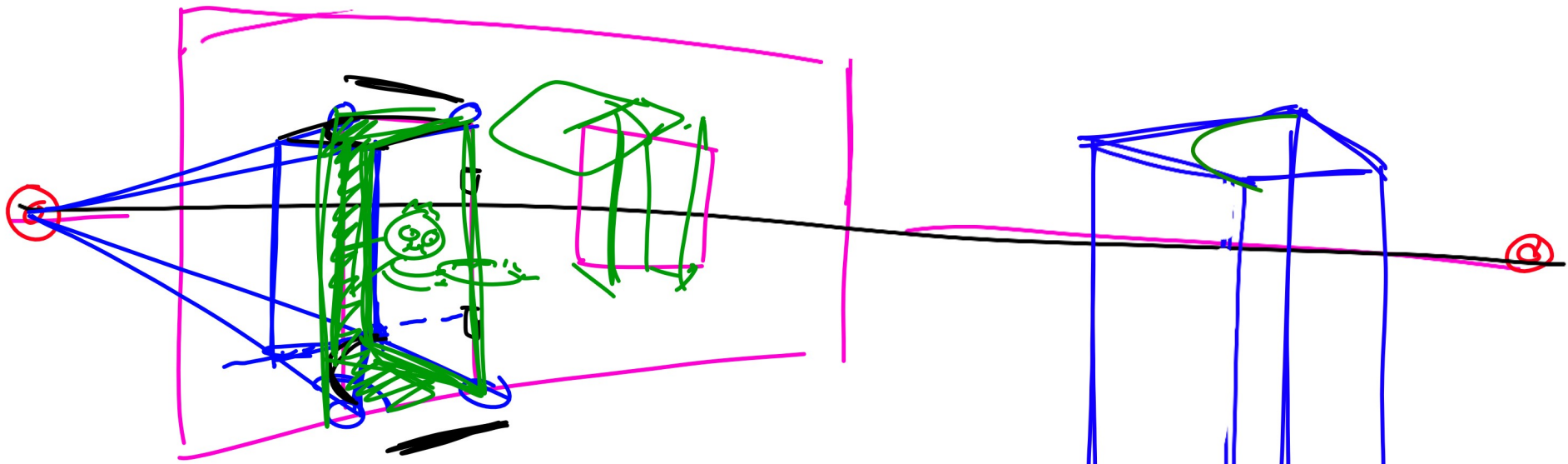

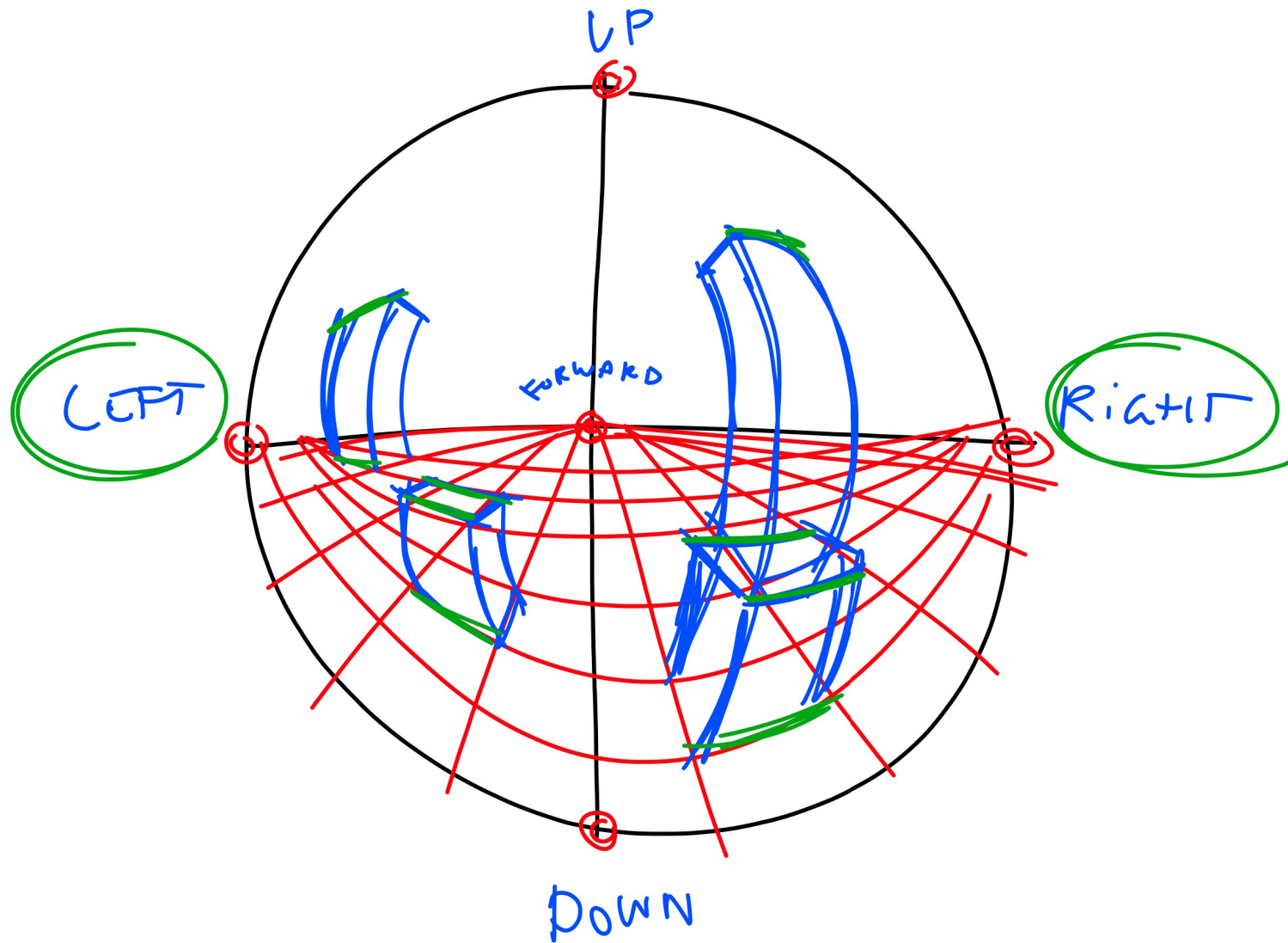



HOGWARTS
DORM ROOM

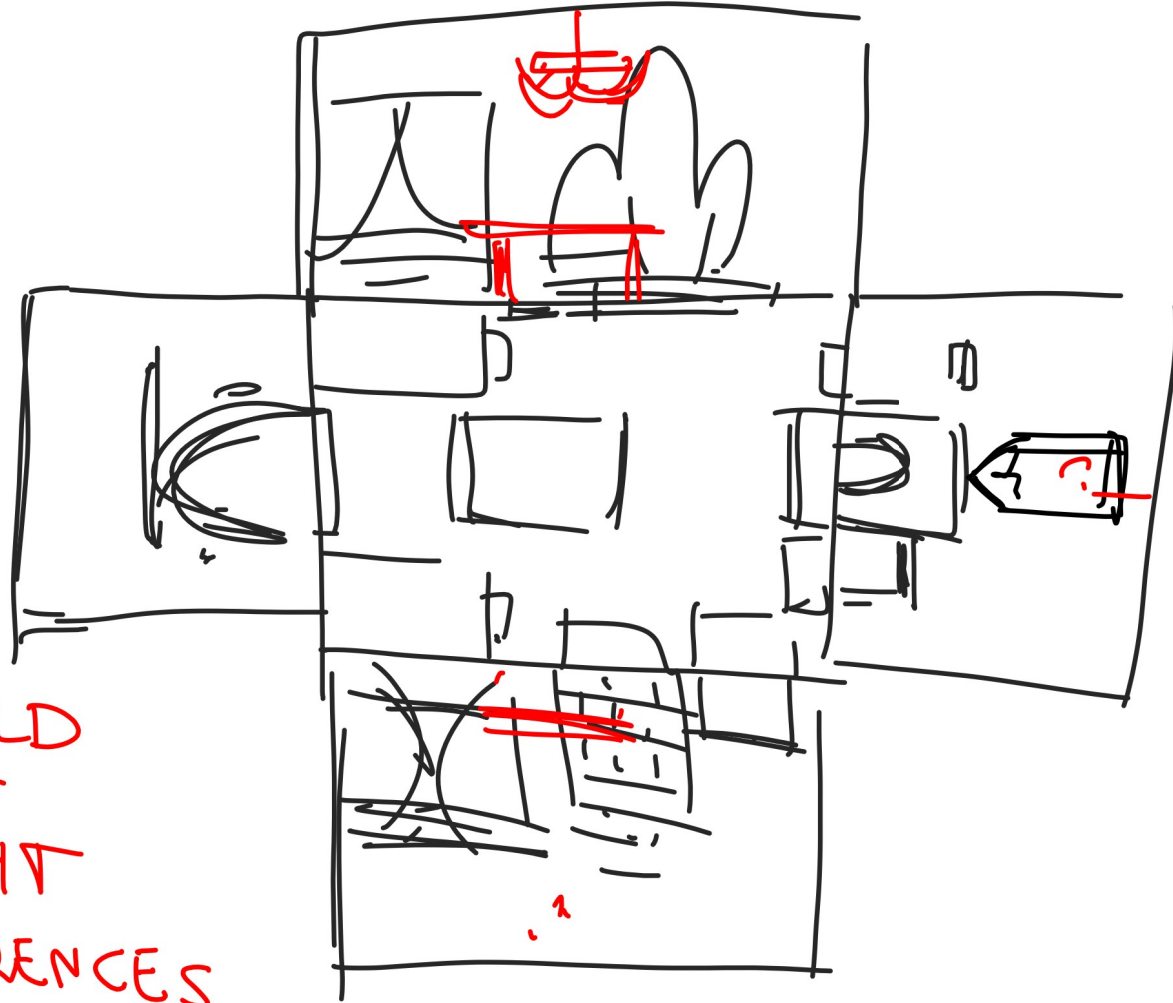

UNFOLD
for
HEIGHT
DIFFERENCES

YOUR FINAL
ASSIGNMENT:

A SHOT from YOUR HOGWARTS ROOM

TELLING THE STORY OF A DAY IN YOUR
SCHOOL LIFE

ENVIRONMENTAL STORYTELLING

PEOPLE = OPTIONAL

1, 2, 3... 5 point!

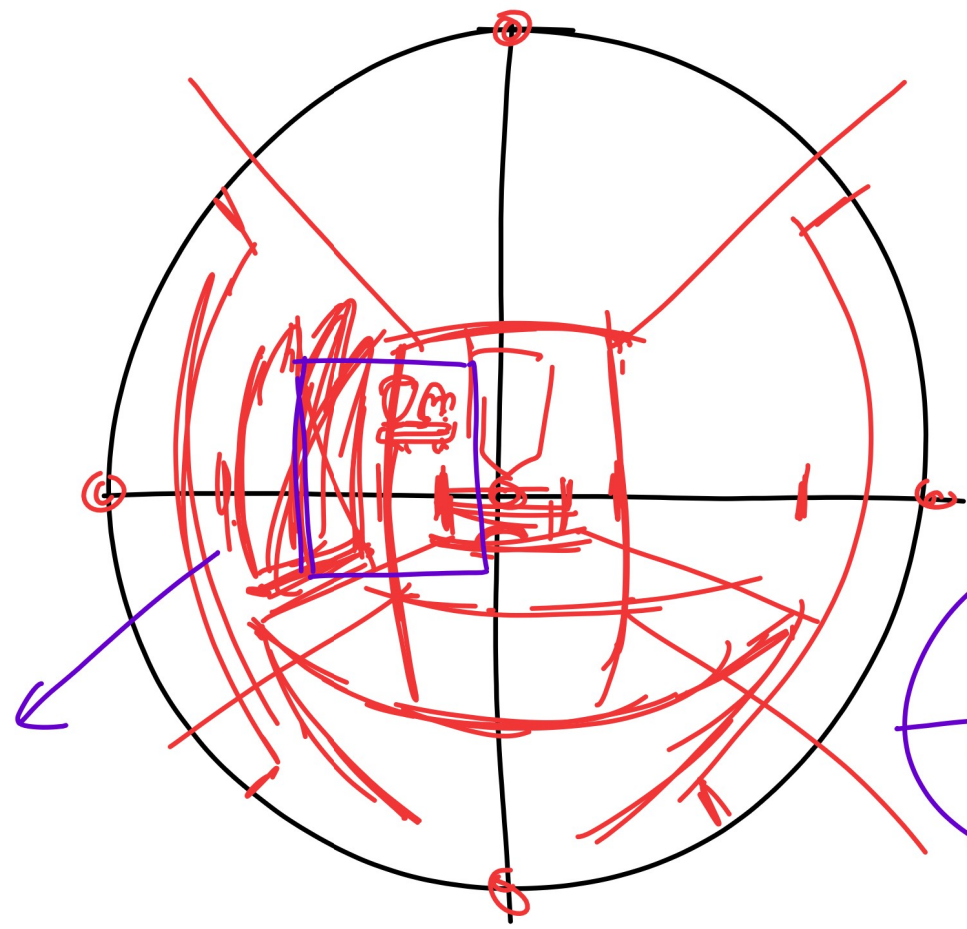
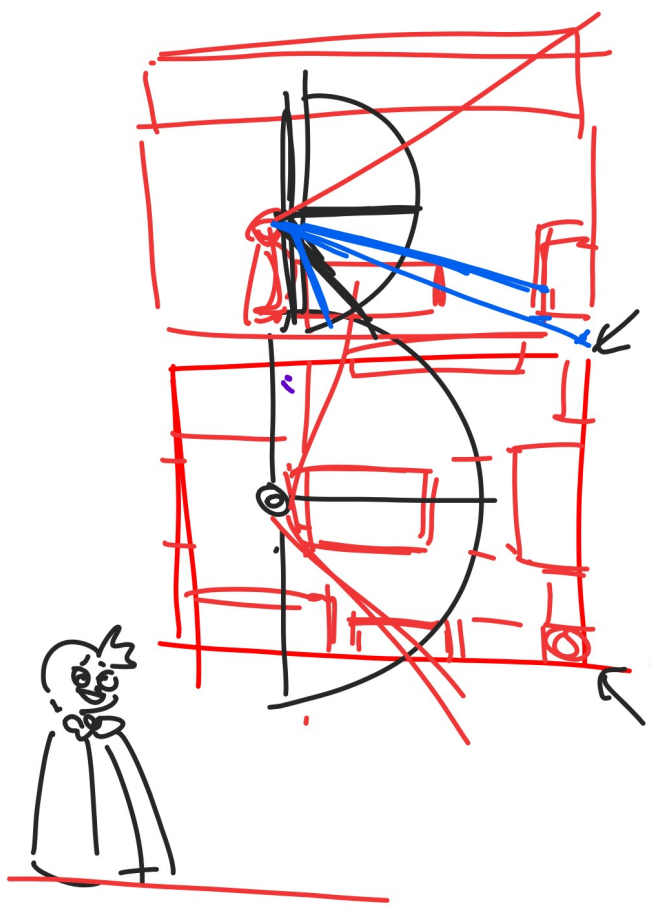

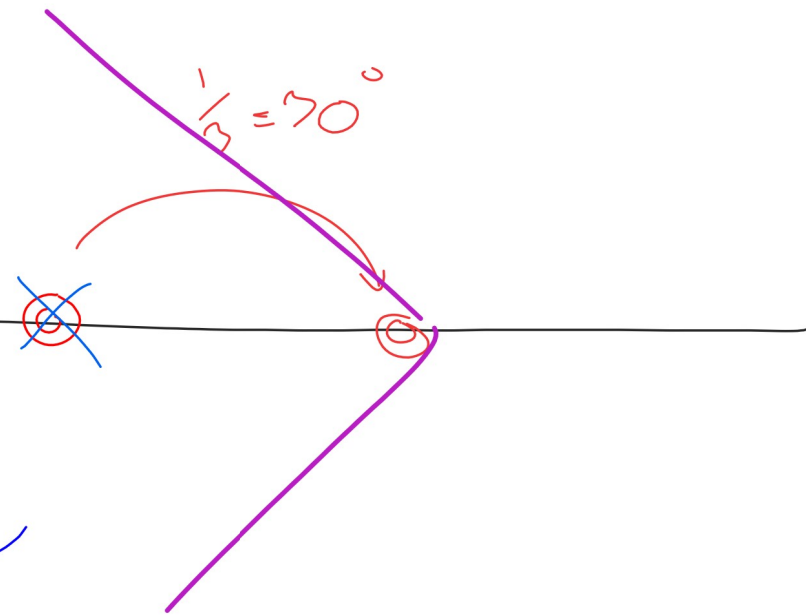
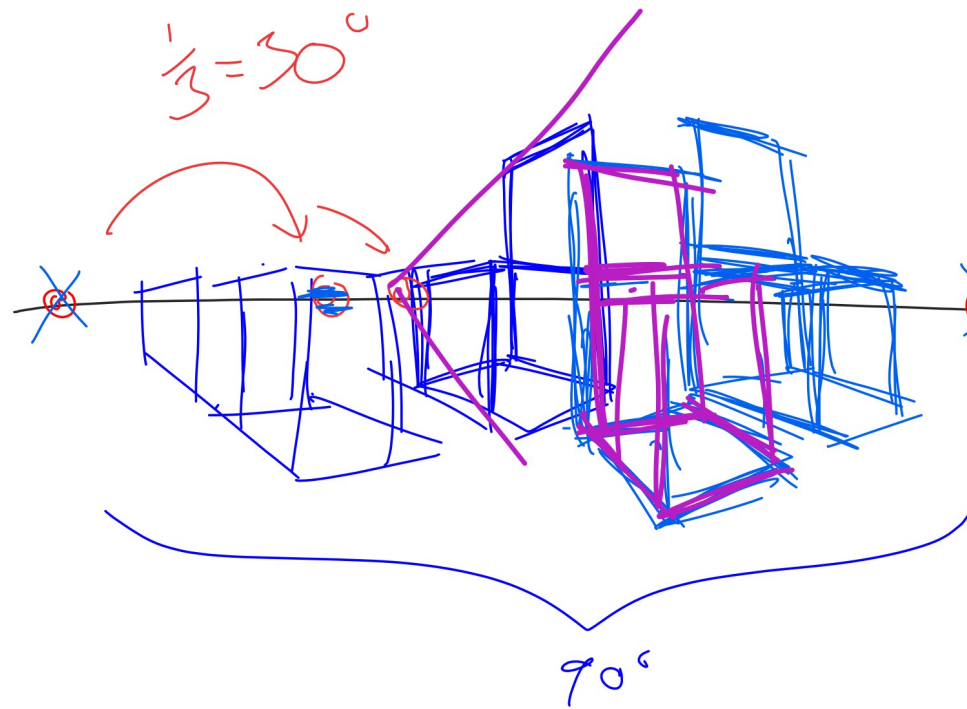

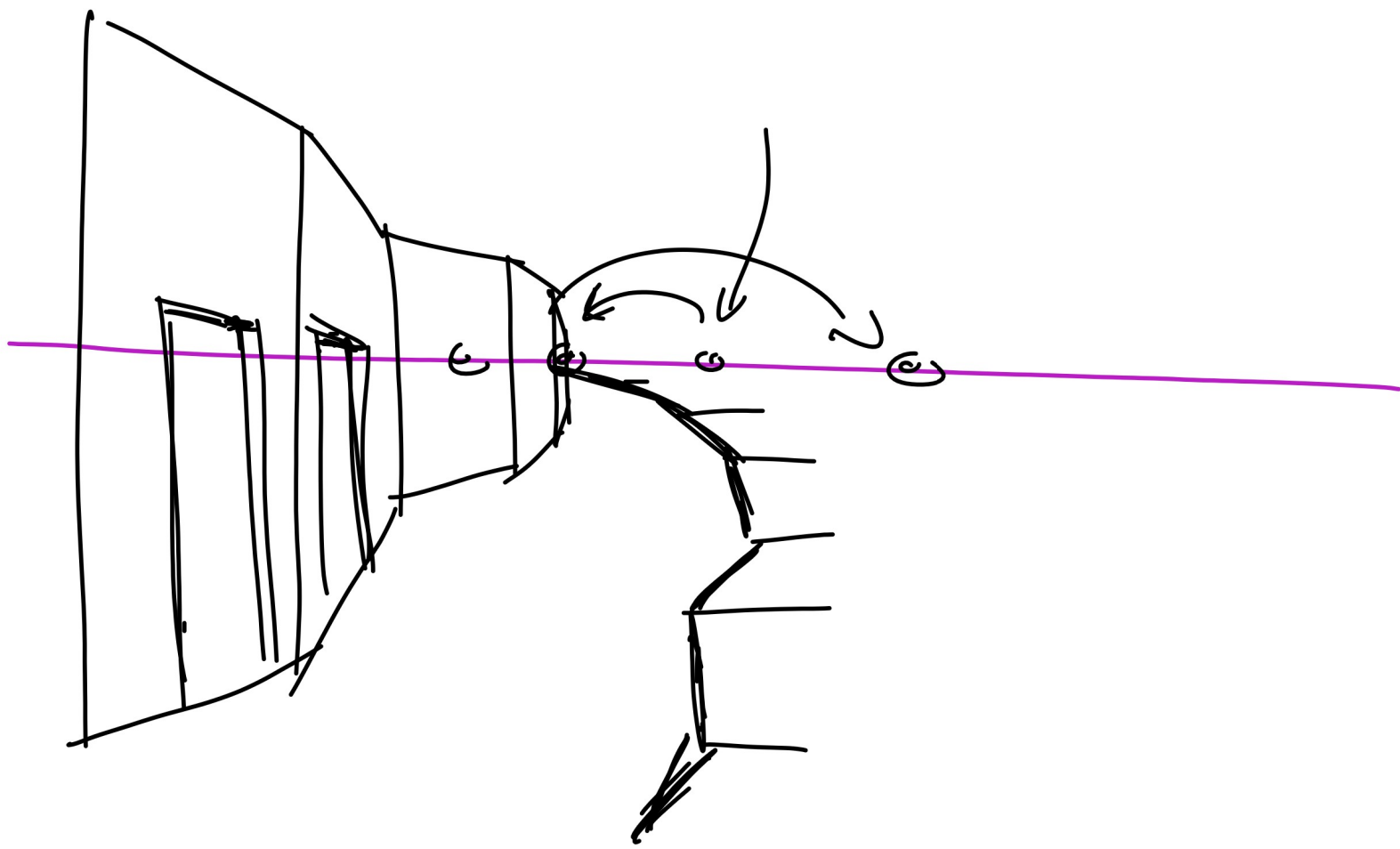

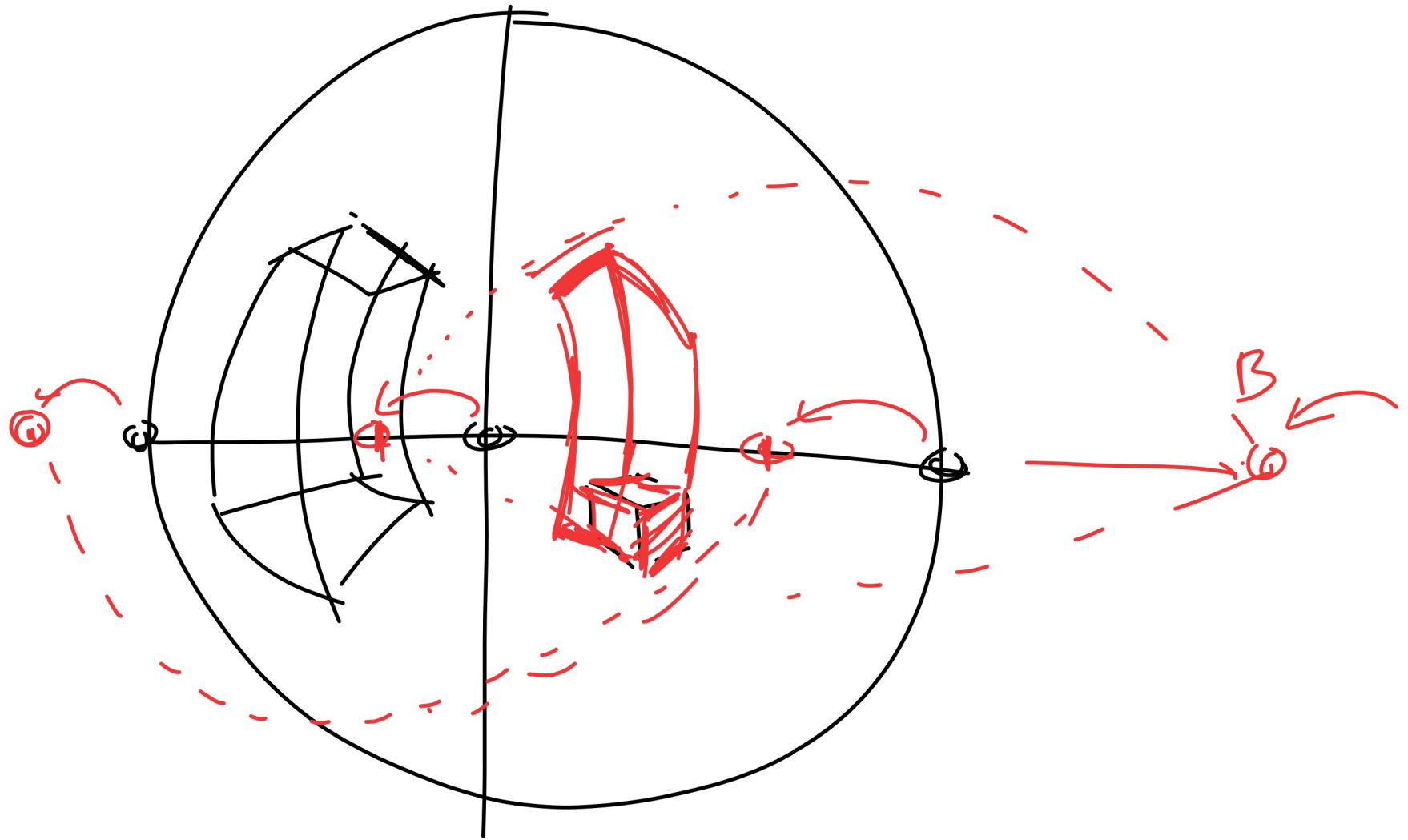

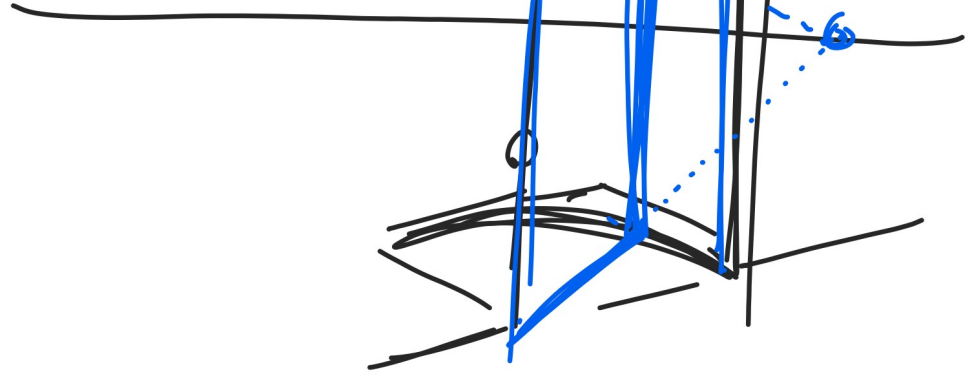
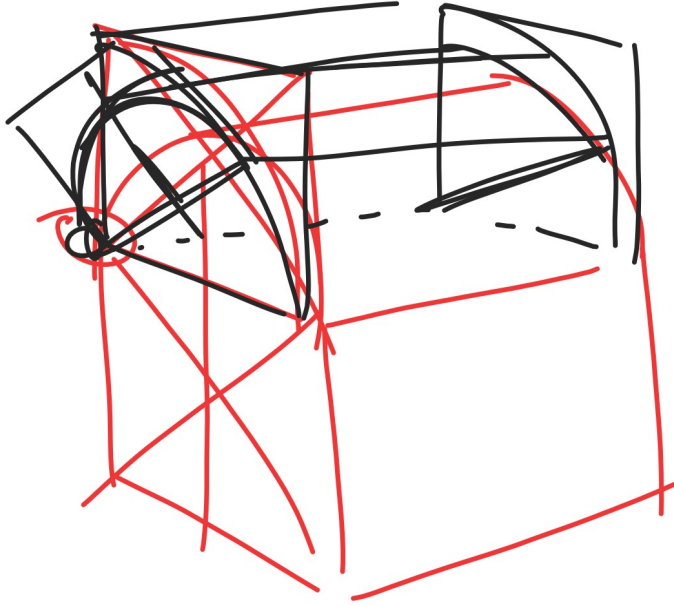

REPETITION

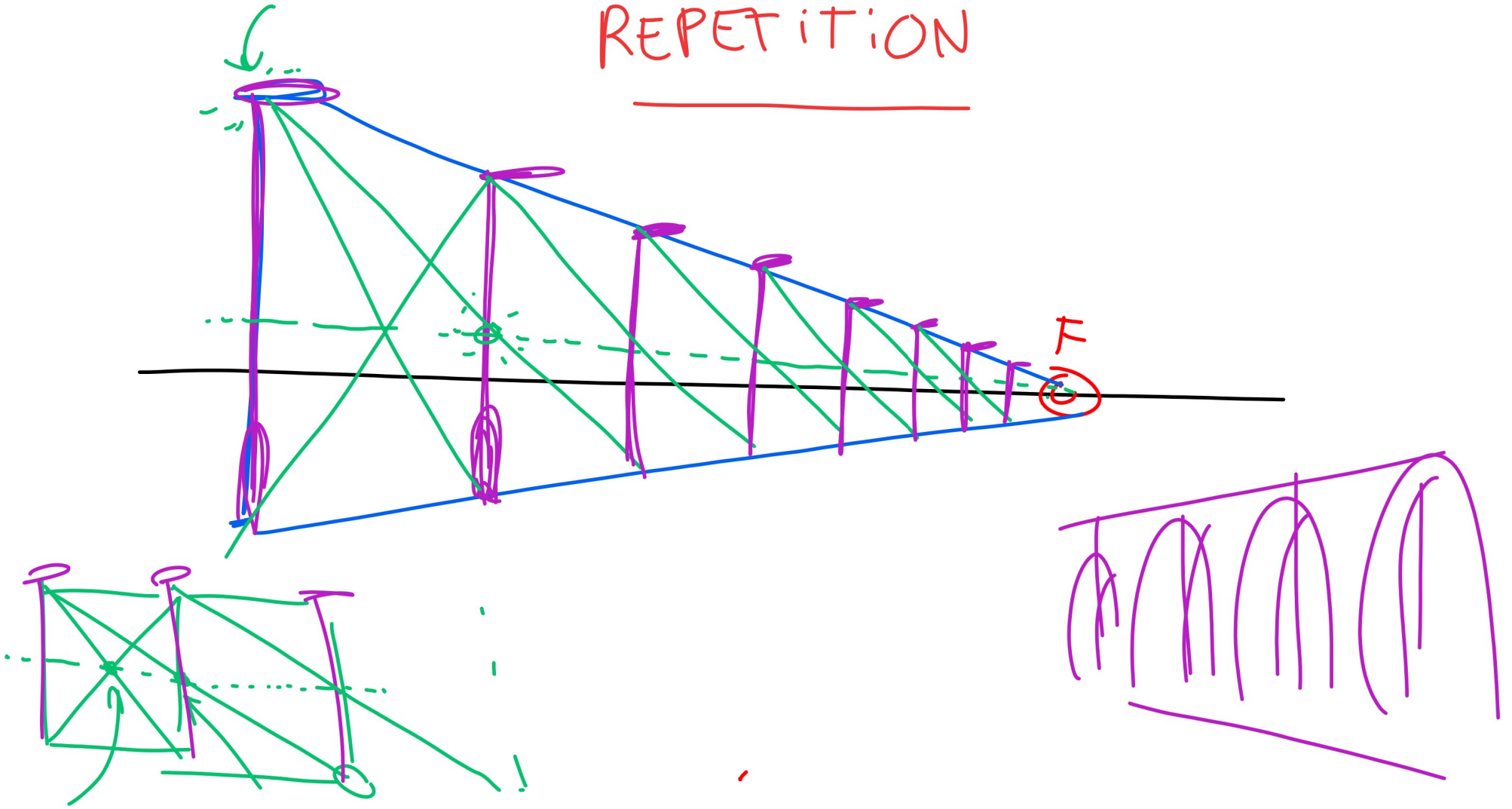

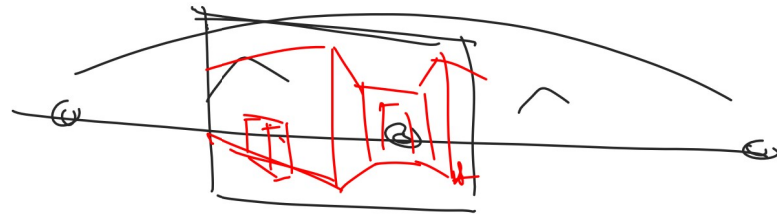
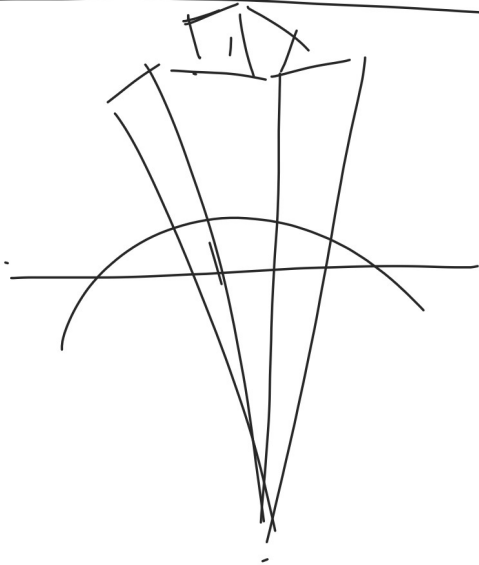
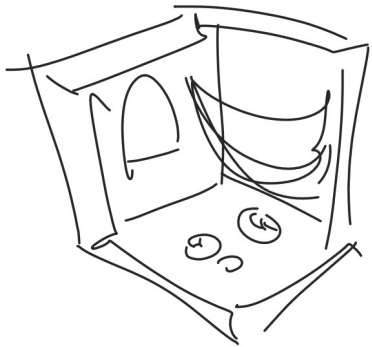
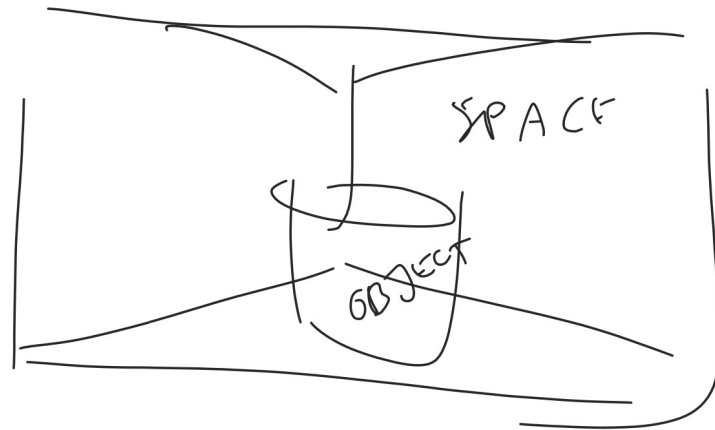
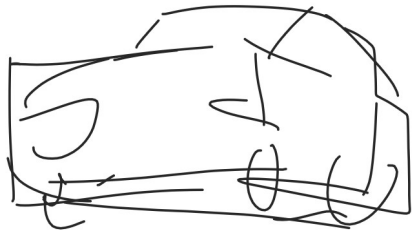

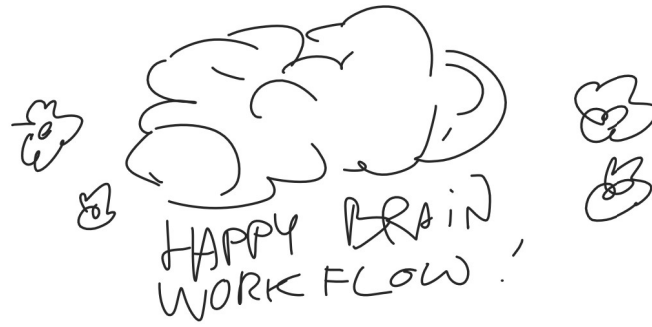

- ① STORY/FEELING
- ② PROPS/SETPIECES
- { ③ FLOOR PLAN
- ④ THUMBNAILS/COMPOSITION
- ⑤ SCAFFOLDING
- ⑥ CONSTRUCTION
- ⑦ DETAILING
- ⑧ RENDERING

{